

Pig Launcher/Receiver 28 inch 150#

Description

PRS International provides and installs pig launching and receiving installations for oil, gas and liquid installations. PRS International is capable to provide launchers and receivers of any size and pressure rating. All launchers / receivers are fully certified and tested before they are send to the costumer.

PRS International Launchers and receivers are designed to accommodate displacement, cleaning, scraper pigs and ILI pigs or any other type of pig. PRS International provides complete solutions for pipeline jobs such as cleaning, drying or displacements.

We have a range of launchers and receivers vary from 4 inch to 48 inch in sizes. See table below for the connections and the specific dimensions of the 28 inch 150# pig launcher/receiver.

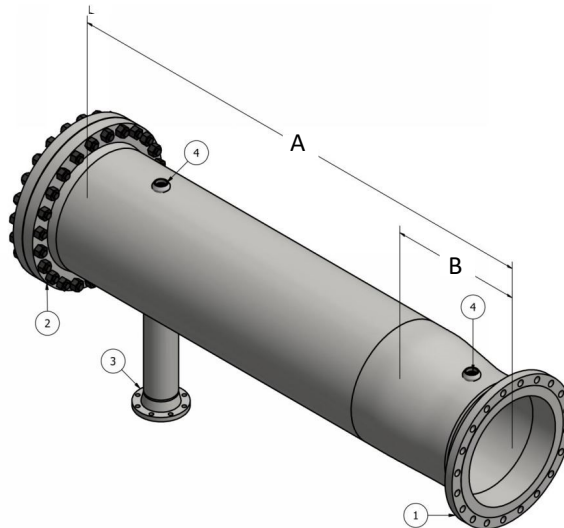

#	Type connections
1	28"WN 150# RF Flange
2	32"WN 150# RF Flange
3	4"WN 150# RF Flange
4	2" NPT Threadolet
All inserts are available for ILI tools	

Parameter	Range
Overall length (A)	2800 mm
Barrel length	1650 mm
Nominal length (B)	630 mm
Flange Class	Class 150
Design pressure	19,65 BARG
Weight	± 2500 kg (incl. flange)